

❏ CRIATIVA, MODERNA, INOVADORA

 **CRIATIVA**[®]
PUXADORES E ACESSÓRIOS

CATÁLOGO

2024

Sobre Nós

Há 27 anos, industrializamos e vendemos produtos em zamac, alumínio, plástico e aço. Atuamos nos ramos moveleiro, de construção civil, vidraceiro, de utilidades e peças técnicas.

A união da equipe de colaboradores, fornecedores e representantes impulsiona a CRIATIVA PUXADORES a conquistar sempre mais mercado, desenvolvendo grandes parcerias com clientes de todo o país.



Missão

Proporcionar praticidade, durabilidade e beleza através da produção e comercialização de puxadores e acessórios de qualidade para móveis, vidros e decorações. Atender seus clientes com agilidade e satisfação.

Filosofia

Creemos na construção de uma empresa com base na seriedade, respeito mútuo, honestidade e responsabilidade social. Trabalhando com otimismo e em busca da evolução contínua de nossa empresa, clientes, colaboradores e comunidade.

Responsabilidade Social

Consciente da sua posição dentro da sociedade e da importância da adoção e valorização de práticas de responsabilidade social, a Criativa Puxadores e Acessórios busca constantemente parcerias que venham a auxiliar o crescimento da sociedade.

Mantemos um projeto de ressocialização de detentos no Presídio Regional de Joaçaba, empregando mão-de-obra direta desde 2005.

SUPORTES PARA PRATELEIRA



SUPORTE 2 FUROS 1024 LIGHT | ZAMAC

ACABAMENTOS Branco / Cromo
PESO APROX. 1,20g

OBSERVAÇÃO

- Acabamento croma: Cobre+Zinco+Cromatizante
- Resistência similar a do níquel



SUPORTE 2 FUROS 1026 TRADICIONAL | ZAMAC

ACABAMENTOS Branco / Niquelado
Natural / Prata
Preto
PESO APROX. 2,0g



SUPORTE 1 PINO E 1 FURO 1026B | ZAMAC

ACABAMENTOS Branco
Niquelado
PESO APROX. 3,5g



SUPORTE 2 FUROS CV 1026 TRADICIONAL | ZAMAC

ACABAMENTO Niquelado
PESO APROX. 2,25g

OBSERVAÇÃO

Com ventosa



SUPORTE 2 FUROS 1027 MACIÇO | ZAMAC

ACABAMENTOS Branco
Niquelado
Preto
PESO APROX. 3,0g



SUPORTE 2 FUROS 1028 MACIÇO EXTRAFORTE | ZAMAC

ACABAMENTOS Branco
Niquelado
PESO APROX. 4,8g



SUPORTE 3 FUROS 2026 | ZAMAC

ACABAMENTOS Branco
Niquelado
Preto
PESO APROX. 3g



BORNE DV 5050 | AÇO

ACABAMENTO Zincado

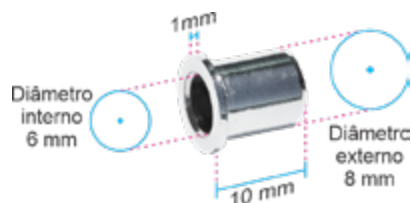

BUCHA PARA SUPORTE 6x8 | ZAMAC

ACABAMENTO Niquelado

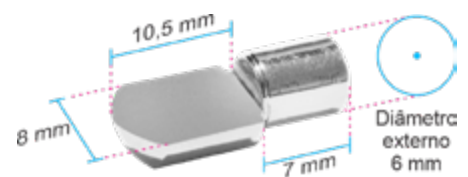

SUPORTE TIPO PAZINHA 6x8 | ZAMAC

ACABAMENTO Niquelado



CANTONEIRA PLÁSTICA INTELIGENTE 4 FUROS | CR 258

ACABAMENTOS
Branco
Transparente

OBSERVAÇÃO
Acompanha parafuso de união central



1
Fixe normalmente a cantoneira com 4 parafusos de sua escolha



2
Para desmontar o móvel, retire apenas o parafuso central. Para remontar é só encaixar as partes e refixar o parafuso central



Branco Transparente

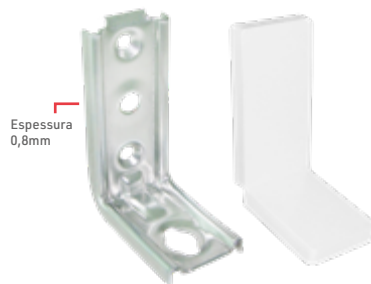

CANTONEIRA METÁLICA COM CAPA PLÁSTICA | DV 3030

CANTONEIRA **COR DA CAPA**
Zincada Branca

TAMANHO **LARGURA**
54x37mm 22mm



CANTONEIRA ZAMAC INTELIGENTE 4 FUROS | CR 2020

ACABAMENTOS
Branco
Prata

OBSERVAÇÃO
Acompanha parafuso de união central



1
Fixe normalmente a cantoneira com 4 parafusos de sua escolha

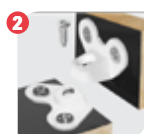

2
Para desmontar o móvel, retire apenas o parafuso central. Para remontar é só encaixar as partes e refixar o parafuso central

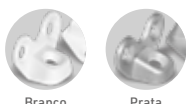

Branco Prata



CANTONEIRA METÁLICA EXTRA REFORÇADA C/ CAPA PLÁSTICA | DV 3060

CANTONEIRA **COR DA CAPA**
Zincada Branca

TAMANHO **LARGURA**
54x26mm 27,5mm

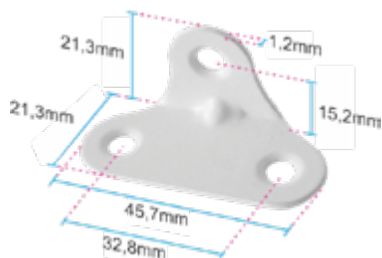

CANTONEIRA UNIVERSAL 3 FUROS | DV 3020

ACABAMENTO **ESPESSURA**
Branco 1,2mm

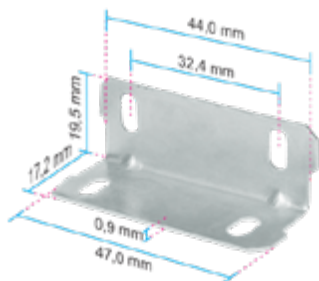

CANTONEIRA 4 FUROS | 1022

ACABAMENTO **ESPESSURA**
Zincado 0,9mm

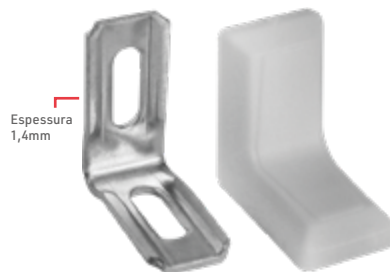

CANTONEIRA METÁLICA COM CAPA PLÁSTICA | 87117

CANTONEIRA **COR DA CAPA**
Zincada Branca

TAMANHO **LARGURA**
30x30mm 12,6mm

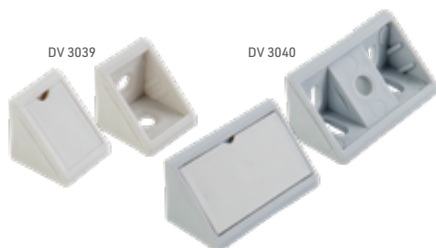

CANTONEIRAS PLÁSTICAS TRIÂNGULO | COM CAPA

REFERÊNCIAS **COR**
DV 3039 - 2 furos Branca
DV 3040 - 4 furos

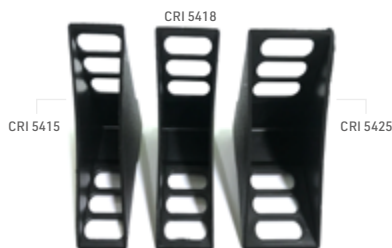

PROTECTOR DE CANTO | PARA MÓVEIS

REFERÊNCIAS **PARA MDF**
CRI 5415 15mm
CRI 5418 18mm
CRI 5425 25mm
ACABAMENTO **MEDIDAS**
Preto 55x55x74mm

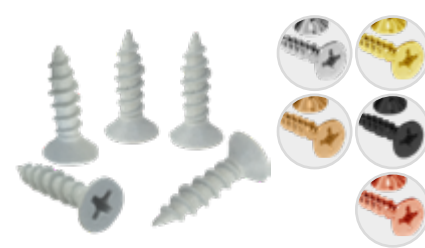

PARAFUSO AUTO-ATARRAXANTE | CABEÇA CHATA

ACABAMENTO **ACABAMENTOS**
Branco Cromado
Dourado brilho
Dourado fosco
Preto
Rosé
TAMANHOS
3,5x14mm
3,5x16mm
4,0x14mm
4,0x16mm
TAMANHO
3,5x16mm



CANTONEIRA | 4 FUROS

REFERÊNCIAS	TAMANHOS	LARG. APROX.	ESP. APROX.	ACABAMENTO
2001	5x5cm	19mm		Bicromatizado
2002	6x10cm		2mm	
2003	7,5x5cm			



CANTONEIRA | LEVE

TAMANHOS	LARG. APROX.	ESP. APROX.	ACABAMENTO
1"x1" (25x25mm)	16mm		Branco
1.1/2"x1.1/2" (38x38mm)		2,2mm	
2"x2" (51x51mm)			
2.1/2"x2.1/2" (63x63mm)			
3"x3" (76x76mm)			
3.1/2"x3.1/2" (89x89mm)			



CANTONEIRAS INOX | 4551

DESCRIÇÃO	TAMANHOS	LARGURA	ESPESSURA
4551A	20x20mm	16mm	1,8mm
4551B	25x25mm		
4551C	30x30mm		
4551D	40x40mm		
4551E	50x50mm		



CANTONEIRAS INOX | 4552

DESCRIÇÃO	TAMANHOS	LARGURA	ESPESSURA
4552A	45x45mm	20mm	2,2mm
4552B	65x65mm		
4552C	85x85mm		
4552D	100x100mm		
4552E	125x125mm		
4552F	150x150mm		



CANTONEIRAS INOX | 4553

DESCRIÇÃO	TAMANHOS	LARGURA	ESPESSURA
4553A	45x45mm	38mm	2,2mm
4553B	65x65mm		
4553C	85x85mm		



CHAPAS INOX | 4554

DESCRIÇÃO	TAMANHOS	LARGURA	ESPESSURA
4554A	36mm	16mm	1,8mm
4554B	46mm		
4554C	56mm		
4554D	76mm		
4554E	96mm		

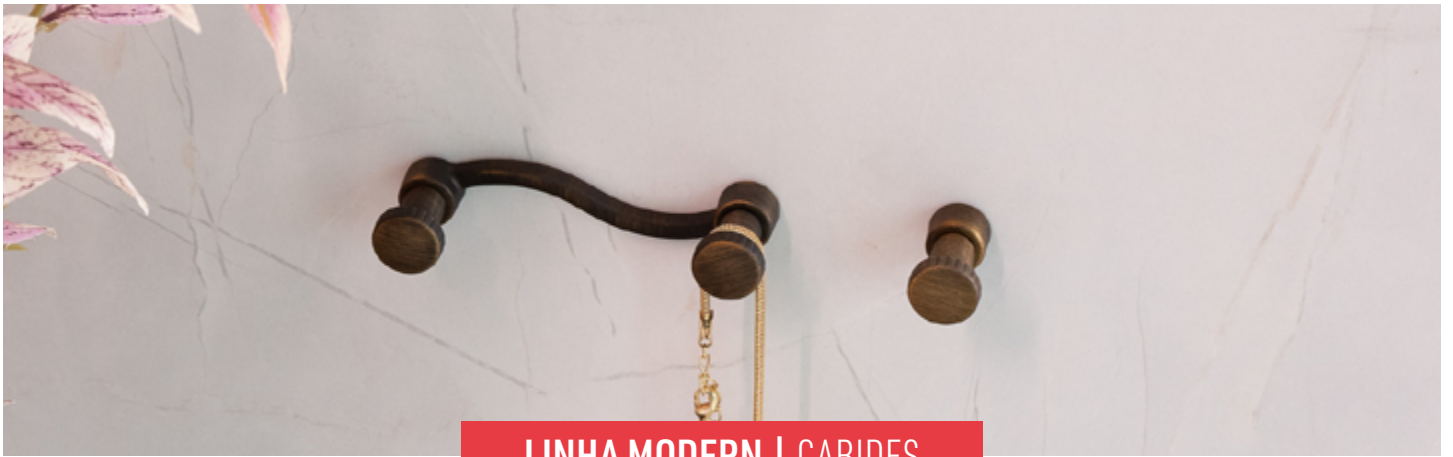

LINHA MODERN | CABIDES



UNIFURO
| ZAMAC



TRIÂNGULO 3 FUROS
| ZAMAC



RETO 2 FUROS
| ZAMAC



RETO 3 FUROS
| ZAMAC

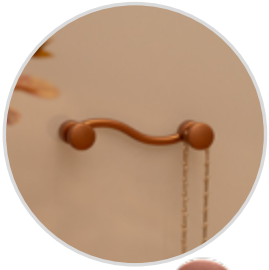

CURVO 2 FUROS
| ZAMAC



CURVO 3 FUROS
| ZAMAC

Todos os cabides desta página estão disponíveis nestes acabamentos: Consulte nosso setor comercial.



Antique fosco



Branco brilho



Cobre



Cromado



Dourado Gold



Grafite Fosco

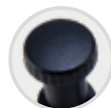

Preto fosco

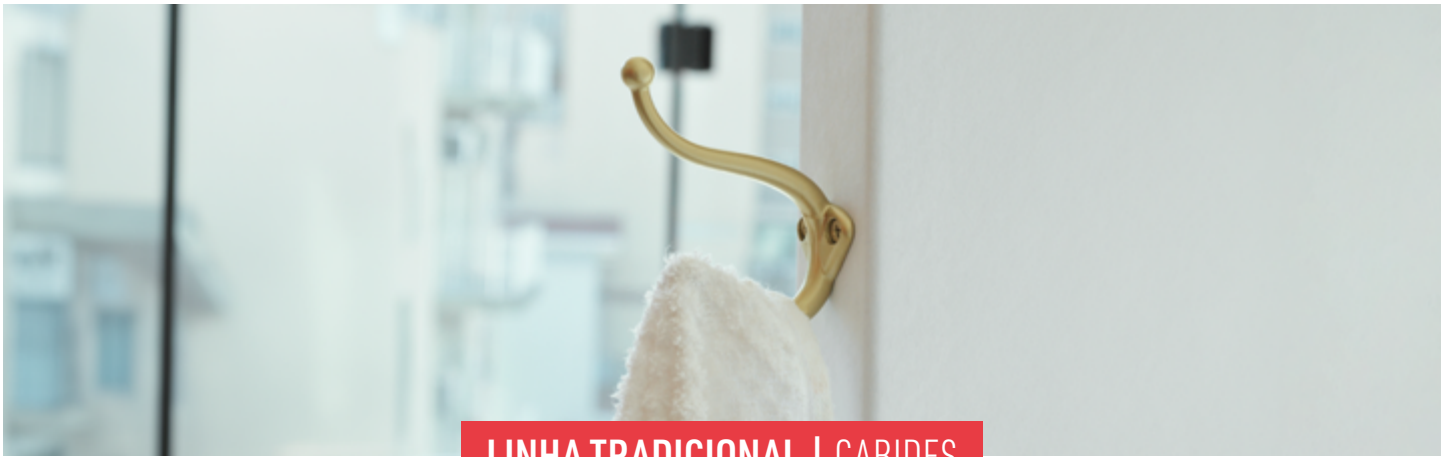

LINHA TRADICIONAL | CABIDES



PEQUENO
| ZAMAC



MÉDIO
| ZAMAC



GRANDE
| ZAMAC



DUPLO
| ZAMAC



GANCHO SIMPLES
| ZAMAC

ACABAMENTOS
Antique brilho / Cromado

OBSERVAÇÃO
Com fixação traseira



GANCHO DUPLO VERTICAL | ZAMAC

ACABAMENTOS
Antique brilho / Cromado

OBSERVAÇÃO
Com fixação traseira

Todos os cabides desta página, exceto o gancho simples e gancho duplo, estão disponíveis nestes acabamentos:
Consulte nosso setor comercial.



Antique brilho



Antique fosco



Branco brilho



Cromado



Dourado brilho



Dourado fosco



Preto fosco



Rosé



BOTÕES DE ACABAMENTO

FORMATO	CHATO	CHANFRADO	CONVEXO	QUADRADO	REDONDO
ACABAMENTOS	Branco brilho Cromado Dourado fosco Preto fosco	Cromado	Cromado	Cromado	Cromado
BRI Botão acabamento com arruela rosca interna			Parafuso com cabeça rosqueada para BAP	Arruela com rosca externa para BRI	Sem parafuso
BAP Botão acabamento com parafuso cabeça rosqueada					



BOTÃO FRANCÊS LISO E FRISADO | ZAMAC

ACABAMENTO
Cromado



BOTÃO FRANCÊS FRISADO | PLÁSTICO

ACABAMENTOS
Cromado / Dourado fosco / Preto fosco



PUXADORES BOX



PUXADOR BOX 5/8" | ZAMAC

ACABAMENTOS
Cromado
Branco

FIXAÇÃO
Com haste M4 e 2 arruelas plásticas



PUXADOR BOX 5000 | ZAMAC

DIÂMETRO SUPERIOR
BOX 5000 MINI: 23,5mm
BOX 5000 TRAD: 28,5mm
BOX 5000 MAX: 34,5mm

FIXAÇÃO
Com haste M4 e 2 arruelas plásticas

ACABAMENTOS
Branco brilho
Cobre
Cromado
Dourado brilho
Dourado fosco
Preto fosco
Rosé



SUPTES PARA VIDRO (SPV)



SPV MINI | ZAMAC

MEDIDA 6mm
ACABAMENTO Cromado

OBSERVAÇÕES

- Embalado individualmente
- Com parafuso lateral rosqueado



SPV LEVE | ZAMAC

MEDIDA 6mm
ACABAMENTO Cromado

OBSERVAÇÕES

- Embalado individualmente
- Com parafuso lateral rosqueado



SPV REDONDO | ZAMAC

MEDIDAS 4mm / 6mm / 8mm / 10mm
ACABAMENTOS Cromado / Preto fosco

OBSERVAÇÕES

- Embalado individualmente
- Com parafuso lateral rosqueado



MEDIDAS 12mm / 16mm / 20mm
ACABAMENTO Cromado



SPV 2 FUROS | ZAMAC

MEDIDA 6mm
ACABAMENTO Cromado

OBSERVAÇÕES

- Embalado individualmente
- Com parafuso lateral rosqueado



SPV OVAL | ZAMAC

MEDIDA 8mm
ACABAMENTO Cromado

OBSERVAÇÕES

- Embalado individualmente
- Com parafuso lateral rosqueado



SPV COM PITÃO | ZAMAC

MEDIDA 4mm
ACABAMENTO Cromado

OBSERVAÇÕES

- Embalado individualmente
- Com parafuso lateral rosqueado



SPV QUADRADO | ZAMAC

MEDIDAS 6mm / 8mm / 10mm
ACABAMENTOS Cromado / Preto fosco

OBSERVAÇÕES

- Embalado individualmente
- Com parafuso lateral rosqueado



SPV QUADRADO EXTRALONGO | ZAMAC

MEDIDA 10mm
ACABAMENTO Cromado

OBSERVAÇÕES

- Embalado individualmente
- Com parafuso lateral rosqueado

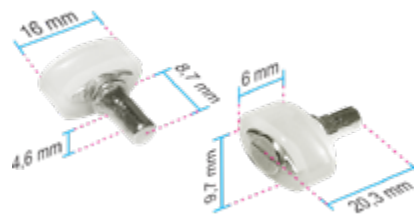

SUPORTE PITÃO COM SILICONE | ZAMAC

ACABAMENTO Niquelado



SUPORTE TUCANO | ZAMAC

REFERÊNCIAS	ACABAMENTO	A	B	C
Mini	Cromado	21,3mm	32,5mm	39,4mm
Pequeno		24mm	40mm	50mm
Médio		27,3mm	46mm	66mm
Grande		37,5mm	68mm	100mm

"Olha que coisa mais linda, mais cheia de graça..."



COLEÇÃO | *Brasilidades*



PUXADOR AQUARELA

FURAÇÃO MEDIDAS
Unifuro 30x16mm

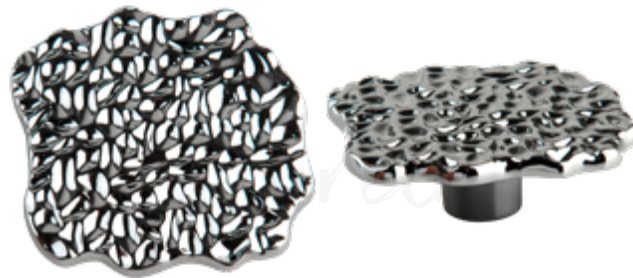

PUXADOR AQUARELA

FURAÇÃO MEDIDAS
Unifuro 55x16mm



PUXADOR GRAMADO

FURAÇÃO MEDIDA MEDIDA
Unifuro PUXADOR BASE
20x20mm 30x30mm



PUXADOR CANELA

FURAÇÃO DIÂMETRO DIÂMETRO
Unifuro PUXADOR BASE
22mm 32mm

Todos os puxadores desta página são produzidos em Zamac e estão disponíveis nestes acabamentos: Consulte nosso setor comercial.



Branco Pérola



Champanhe



Cobre



Cromado



Dourado Gold



Grafite Fosco



Onix



Preto Fosco



PUXADOR IGUAÇU

FURAÇÃO	DIÂMETRO	COMPIMENTO
Unifuro	BASE 35mm	62mm



PUXADOR INTERLAGOS

FURAÇÃO	MEDIDAS
Unifuro	90x34mm



PUXADOR IPANEMA

FURAÇÃO	MEDIDAS
32mm	66x45mm



PUXADOR IPANEMA

FURAÇÃO	MEDIDAS
64mm	94x45mm

Todos os puxadores desta página são produzidos em Zamac e estão disponíveis nestes acabamentos: Consulte nosso setor comercial.

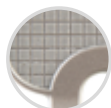

Branco Pérola



Champanhe



Cobre



Cromado



Dourado Gold



Grafite Fosco



Onix



Preto Fosco



PUXADOR CATARINA

FURAÇÃO MEDIDAS
64mm 83x45mm

OBSERVAÇÃO
Acompanha parafuso na cor do puxador



PUXADOR AMAPÁ

FURAÇÃO MEDIDAS
32mm 21x81mm

OBSERVAÇÃO
Com aplique preto em todos os acabamentos



PUXADOR AMAPÁ

FURAÇÃO MEDIDAS
96mm 21x153mm

OBSERVAÇÃO
Com aplique preto em todos os acabamentos



PUXADOR ESPLANADA

FURAÇÃO MEDIDAS
96mm 109x25mm

Todos os puxadores desta página são produzidos em Zamac e estão disponíveis nestes acabamentos: Consulte nosso setor comercial.



Branco Pérola



Champanhe



Cobre



Cromado



Dourado Gold



Grafite Fosco



Onix



Preto Fosco



PUXADOR AMAZONAS

FURAÇÃO 64mm **MEDIDAS** 105x57mm



PUXADOR BRÁS

FURAÇÃO 32mm **MEDIDAS** 100x30mm



PUXADOR MAUÁ

FURAÇÃO 32mm **MEDIDAS** 74x47mm



PUXADOR QUINTANA

FURAÇÃO 64mm **MEDIDAS** 86x86mm



PUXADOR TUPI

FURAÇÃO 32mm **MEDIDAS** 96x48mm

Todos os puxadores desta página são produzidos em Zamac e estão disponíveis nestes acabamentos: Consulte nosso setor comercial.



Branco Pérola



Champanhe



Cobre



Cromado



Dourado Gold



Grafite Fosco



Onix

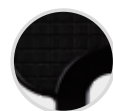

Preto Fosco



COLEÇÃO |
Alfa



PUXADOR GIRARE | ZM 22

FURAÇÃO DIÂMETRO SUPERIOR
Unifuro 22mm



DUOMO 23mm | ZM 5000 MINI
DUOMO 28mm | ZM 5000 TRADICIONAL
DUOMO 34mm | ZM 5000 MAX

FURAÇÃO DIÂMETRO SUPERIOR
Unifuro ZM 5000 MINI: 23,5mm
ZM 5000 TRAD: 28,5mm
ZM 5000 MAX: 34,5mm



PUXADOR FONTANA | ZM 3238

FURAÇÃO MEDIDAS
Unifuro 35x30mm

Todos os puxadores desta página são produzidos em Zamac e estão disponíveis nestes acabamentos:
Consulte nosso setor comercial.



Antique
brilho



Antique
fosco



Branco
brilho



Cobre



Cromado



Dourado
brilho



Dourado
fosco



Preto
fosco



Rosé



PUXADOR UNO | 5/8"

FURAÇÃO DIÂMETRO
Unifuro 15,9mm



PUXADOR MERCATO | ZM 20

FURAÇÃO MEDIDAS
Unifuro 20x20mm



PUXADOR MERCATO | ZM 30

FURAÇÃO MEDIDAS
Unifuro 30x30mm



PUXADOR GANGORRA

FURAÇÃO MEDIDAS
32mm 40x40mm



PUXADOR TEATRO | ZM 16

FURAÇÃO MEDIDAS
16mm 36x22mm

Todos os puxadores desta página são produzidos em Zamac e estão disponíveis nestes acabamentos:
Consulte nosso setor comercial.



Antique brilho



Antique fosco



Branco brilho



Cobre



Cromado



Dourado brilho



Dourado fosco



Preto fosco



Rosé



PUXADOR VIALE

FURAÇÕES
32mm / 64mm / 96mm



PUXADOR MAXIMUS | CZM 04

FURAÇÕES
64mm / 96mm / 128mm



PUXADOR SONETO | CONCHA

FURAÇÕES
20mm / 64mm



PUXADOR MIRACOLI | ZM 5015

FURAÇÕES
96mm / 128mm / 160mm / 192mm



PUXADOR PALATINO | ZM 55

FURAÇÕES
96mm / 128mm / 160mm / 192mm

Todos os puxadores desta página são produzidos em Zamac e estão disponíveis nestes acabamentos:
Consulte nosso setor comercial.



Antique brilho



Antique fosco



Branco brilho



Cobre



Cromado



Dourado brilho



Dourado fosco



Preto fosco



Rosé



PUXADOR NOBILE | DZ 28

FURAÇÃO 128mm
FURAÇÃO AUXILIAR 119mm
COMPRIMENTO 142mm



PUXADOR NOBILE | DZ 60

FURAÇÃO 160mm
FURAÇÃO AUXILIAR 151mm
COMPRIMENTO 175mm



PUXADOR TRADIÇÃO | DZ 950

FURAÇÃO 90mm
COMPRIMENTO 100mm



PUXADOR TRADIÇÃO | DZ 954

FURAÇÃO 105mm
COMPRIMENTO 120mm

Todos os puxadores desta página são produzidos em Zamac e estão disponíveis nestes acabamentos: Consulte nosso setor comercial.



Antique brilho



Antique fosco



Branco brilho



Cromado



Dourado brilho



Dourado fosco



Preto fosco



Rosé



PUXADOR MOVELEIRO EM ZAMAC | CR 3172

FURAÇÕES

96mm / 128mm / 160mm / 192mm / 224mm / 256mm

ACABAMENTOS

Cobre
Cromado
Cromado fosco
Dourado fosco
Lateral cromado com meio cromado fosco
Preto fosco



PUXADORES MOVELEIROS



PUXADOR COLONIAL PZ 36 | 1085

ACABAMENTO Antique rústico
MATERIAL Zamac



PUXADOR COLONIAL PZ 31 | 1084

ACABAMENTO Antique rústico
MATERIAL Zamac



PUXADOR COLONIAL PZ 27 | 1082

ACABAMENTO Antique rústico
MATERIAL Zamac



PUXADOR COLONIAL PZ 28 | 1083

ACABAMENTO Antique rústico
MATERIAL Zamac



CHAVE COLONIAL | 1030

ACABAMENTO Antique rústico
MATERIAL Zamac

• Chave utilizada na Fechadura 012



FECHADURA 012 | 2 VOLTAS

ACABAMENTO Zincado
OBSERVAÇÃO Acionamento com a Chave Colonial 1030



TAMPAS E ACABAMENTOS | ZAMAC

Disponibilizamos **mais de 150 modelos**. Solicite o desenho técnico ou amostra ao nosso representante.

Desenvolvemos modelos e cores **sob encomenda**. Consulte nosso setor comercial.



| TAMPAS COM PINOS PARALELOS
MAIS DE 30 MODELOS DISPONÍVEIS



| TAMPAS COM ABAS DE PRESSÃO
MAIS DE 25 MODELOS DISPONÍVEIS



| TAMPAS COM PINOS TRANSVERSAIS
MAIS DE 30 MODELOS DISPONÍVEIS



| TAMPAS ESPECIAIS
MAIS DE 10 MODELOS DISPONÍVEIS

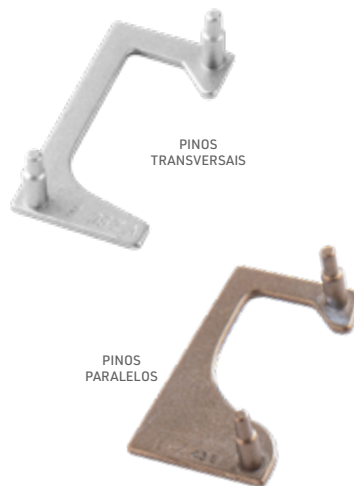

| TAMPAS VAZADAS
MAIS DE 50 MODELOS DISPONÍVEIS

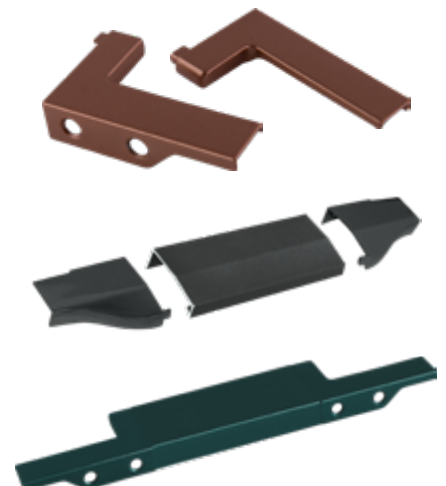

| BASES ESPECIAIS
MAIS DE 30 MODELOS DISPONÍVEIS

Todos os itens desta página estão disponíveis nestes acabamentos:
Outros acabamentos sob encomenda. Consulte nosso setor comercial.



Alumínio fosco



Cromado

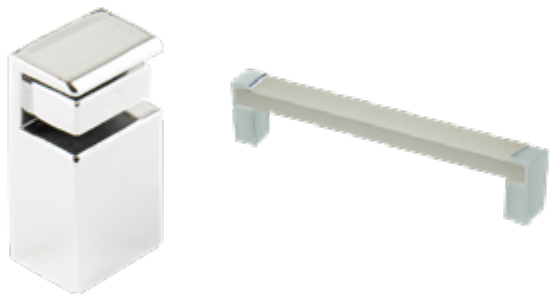

| BRIDGE

BASE PARA UTILIZAR EM PERFIL DE 8 X 15,8MM

BASE ZAMAC
Cromado



| SLIM

BASE PARA UTILIZAR EM PERFIL DE 8 X 15,8MM

BASE ZAMAC
Cromado

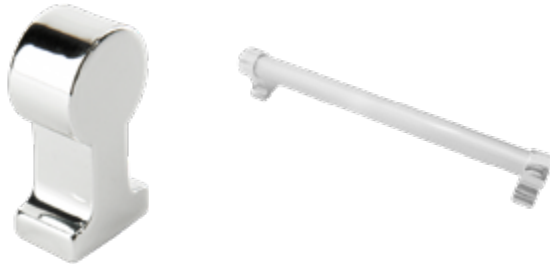

| TURNO 1/2"

BASE PARA UTILIZAR EM PERFIL

BASE ZAMAC
Cromado



| PIAZZA 3/8" E 1/2"

BASE PARA UTILIZAR EM PERFIL

BASE ZAMAC
Cromado



| TAMPA INTERNA PARA TUBO 1"

ACABAMENTOS

Cromado
Natural (sem acabamento)

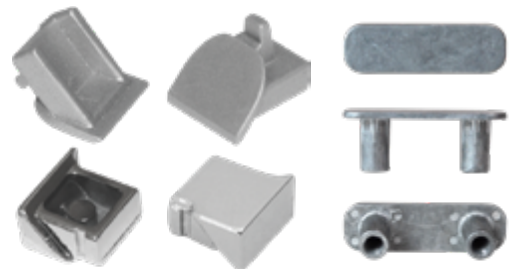

| PEÇAS TÉCNICAS

DIVERSOS MODELOS DESENVOLVIDOS



| PUXADOR STAR

PERFIL DE ALUMÍNIO BASE ZAMAC

PUXADOR STAR

BARRA

ACABAMENTOS
Perfil anodizado fosco
Base cromada

ACABAMENTO
Anodizado fosco

TAMANHO
3 metros

FURAÇÕES
32mm / 64mm
96mm / 128mm
160mm / 192mm
288mm / 576mm



| BASE STAR

ACABAMENTOS
Cromado
Alumínio fosco

OBSERVAÇÃO
Base para utilizar em
ambos os lados do perfil

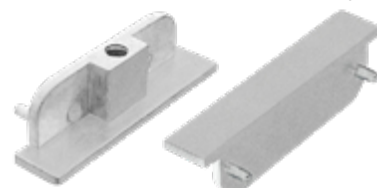

| BASE VERCE

ACABAMENTOS
Cromado
Alumínio fosco

OBSERVAÇÃO
Base para utilizar em
ambos os lados do perfil

PUXADORES PLÁSTICOS



DV 2004
FURAÇÕES 96mm / 128mm / 160mm
COR ALUF



DV 2005
FURAÇÕES 96mm / 128mm
COR ALUF com CRC



DV 2007
FURAÇÃO 160mm
COR Transparente com CRC



DV 2003
FURAÇÕES 96mm / 128mm / 160mm
COR ALUF



01A PARATI
FURAÇÃO Unifuro
CORES BRA / MOG
 Com frizo dourado



01A LÍDER I PEQUENO
FURAÇÃO Unifuro
CORES BRD / CED / MAD / MOD



11A LÍDER II GRANDE
FURAÇÃO Unifuro
CORES BRD / CED / MAD / MOD



05A BOLA PEQUENA
FURAÇÃO Unifuro
COR CRC



08A BOLA GRANDE
FURAÇÃO Unifuro
CORES ALUF / BRA / CRC / DRD



09 ROMA
FURAÇÕES 64mm / 96mm
COR CRC * COM BASE



13 SOFT
FURAÇÕES 96mm / 128mm
COR CRC * COM BASE



14A CECÍLIA
FURAÇÃO 64mm
CORES BRD / CED / MOD



19 ROBUSTO
FURAÇÃO 96mm
CORES ALUF / CRC / DRD * COM BASE



20B VILAGE II
FURAÇÃO Unifuro
CORES ALUF / CRC / DRD



51A MOEMA
FURAÇÃO 64mm
CORES BRD / CED / MOD



54 ARCO E FLECHA
FURAÇÃO 192mm
COR ALUF



57 FLORA
FURAÇÕES 64mm / 96mm / 128mm / 160mm
COR ALUF



58 GOLFINHO
FURAÇÕES 64mm / 96mm / 128mm
COR CRC



70 FLASH
FURAÇÃO 128mm
COR ALUF com Onix



2000 PRINCES
FURAÇÕES 96mm / 128mm / 160mm
COR CRC



2055 LUX
FURAÇÕES 96mm / 128mm / 160mm
COR CRC



2061A TEXAS
FURAÇÃO Unifuro
COR ALUF



2064 ITAPEMA
FURAÇÕES 96mm / 128mm
COR ALUF



0171 SLIM
FURAÇÕES MÚLTIPLAS 96 / 128 / 160mm e 192 / 224mm
COR ALUF



0173 PRIME
FURAÇÕES MÚLTIPLAS 64 / 96 / 128mm e 128 / 160 / 192mm
COR ALUF



0280 BERGAMO
FURAÇÃO 192mm
COR CRC



0288 LUKA
FURAÇÕES 192mm / 256mm
COR CRC



0289 LUXOR
FURAÇÕES 128mm / 256mm
CORES ALUF / CRC



03006 DAKAR
FURAÇÃO 256mm
CORES ALUF / CRC



RODÍZIO DE SILICONE
| SEM TRAVA

COR DA RODA	DIÂMETRO DA RODA
Transparente	35mm 50mm 75mm



RODÍZIO DE SILICONE
| COM TRAVA

COR DA RODA	DIÂMETRO DA RODA
Transparente	35mm 50mm 75mm



RODÍZIO PLÁSTICO COM CHAPA | SEM TRAVA

COR DA RODA	DIÂMETRO DA RODA
Preta	32mm 40mm 50mm



RODÍZIO PLÁSTICO COM CHAPA | COM TRAVA

COR DA RODA	DIÂMETRO DA RODA
Preta	40mm 50mm



PÉ DE AÇO
| FIXO

DIÂMETRO	ALTURAS	COR
50mm	5cm 10cm 15cm	Cromado

• Espessura do tubo: 0,6mm



PÉ PLÁSTICO REDONDO
FIXO | CRI 010

DIÂMETRO	FURO
30mm	3,5mm

ALTURA	CORES
130mm	Branco Preto



PÉ PLÁSTICO
RETANGULAR FIXO
| CRI 72

MEDIDAS	FURO
37 a 54mm	5mm

ALTURA	CORES
160mm	Branco Preto



PÉ PLÁSTICO CÔNICO
TAÇA FIXO | CRI 012

DIÂMETRO	FURO
29 a 48mm	4mm

ALTURA	CORES
49mm	Branco Preto



PÉ PLÁSTICO COM
REGULAGEM | AL 17

DIÂMETRO	TAMANHO	CORES
33mm	129 a 200mm	Branco Cinza Preto

• Com pino plástico para fixação



PÉ PLÁSTICO COM
REGULAGEM | AL 20

DIÂMETRO CÔNICO	TAMANHO	CORES
Superior 40mm Inferior 33mm	170 a 215mm	Branco Cinza Preto

• Com base plástica para fixação com parafuso



PÉ PLÁSTICO CÔNICO COM
REGULAGEM | CRI 730

DIÂMETRO	FURO	FURO CENTRAL
27,5 a 42,5mm	5mm	2,5mm

ALTURA	CORES
180 a 190mm	Branco Preto



PÉ PLÁSTICO
QUADRADO CÔNICO COM
REGULAGEM | CRI 740

LARGURA	FURO	ALTURA	CORES
25 a 40mm	4mm	170 a 195mm	Branco Preto



PÉ PLÁSTICO
FIXO | AL 46

HASTE	DIÂMETRO	ALTURA	COR
5/16"	40mm	128mm	Preto

• Com porca garra



PÉ PLÁSTICO COM
RODÍZIO | AL 45

HASTE	DIÂMETRO	ALTURA	COR
5/16"	40mm	128mm	Preto

• Com porca garra



PÉ DE AÇO COM REGULAGEM | CÔNICO

DIÂMETROS (Cônico) De 12,7 a 25,4mm
ALTURAS 8cm / 10cm
 12cm / 15cm
 20cm
ACABAMENTO Cromado



PÉ DE AÇO COM REGULAGEM | QUADRADO

LARGURA 25x25mm
ALTURAS 5cm / 8cm
 10cm / 12cm
 15cm / 20cm
ACABAMENTO Cromado



PÉ DE AÇO COM REGULAGEM | REDONDO

DIÂMETRO 30mm
ALTURAS 5cm / 8cm
 10cm / 12cm
 15cm / 20cm
ACABAMENTO Cromado

OBSERVAÇÕES

- Ponteira inferior com revestimento metálico cromado
- Chapa de fixação de 60x60mm
- Regulagem que permite aumentar o pé em até 1,5cm



PÉ DE ALUMÍNIO | REDONDO

DIÂMETRO 38mm
DIÂMETRO 51mm
ALTURAS 5cm / 10cm / 15cm
ALTURAS 5cm / 10cm / 15cm
ACABAMENTO Polido
ACABAMENTO Polido

- Parte interna toda de madeira e feltro na base
- Com porca garra



PÉ DE ALUMÍNIO | QUADRADO

LARGURA 38x38mm
LARGURA 51x51mm
ALTURAS 5cm / 10cm / 15cm
ALTURAS 5cm / 10cm / 15cm
ACABAMENTO Polido
ACABAMENTO Polido

- Parte interna toda de madeira e feltro na base
- Com porca garra



PÉ DE ALUMÍNIO COM FLANGE | REDONDO

DIÂMETRO 51mm
ALTURAS 5,5cm
 10cm
 15cm
ACABAMENTO Polido

- Com ponteira inferior plástica (preta)



PÉ DE ALUMÍNIO COM FLANGE E NIVELADOR | REDONDO

DIÂMETRO 51mm
ALTURAS 7,5cm
 10cm
 15cm
ACABAMENTO Polido

- Com nivelador plástico para regulagem
- Regulagem que permite aumentar o pé em até 1,5cm



PÉ DE ALUMÍNIO COM FLANGE | QUADRADO

LARGURA 40x40mm
ALTURAS 5,5cm
 10cm
 15cm
ACABAMENTOS Anodizado fosco
 Polido

- Com ponteira inferior plástica (preta)



PÉ DE ALUMÍNIO COM FLANGE E NIVELADOR | QUADRADO

LARGURA 40x40mm
ALTURAS 7,5cm
 10cm
 15cm
ACABAMENTOS Anodizado fosco
 Polido

- Com nivelador plástico para regulagem
- Regulagem que permite aumentar o pé em até 1,5cm



**SUPORTE CABIDEIRO DV 606
SPIN OBLONGO | ZAMAC**

ACABAMENTOS
Branco brilho / Cromado
Dourado fosco / Preto fosco



**SUPORTE CABIDEIRO DV 607
SPIN REDONDO | ZAMAC**

ACABAMENTOS
Branco brilho / Cromado
Dourado fosco / Preto fosco



**SUPORTE CABIDEIRO DV 806
OBLONGO | ZAMAC**

ACABAMENTOS
Branco brilho / Cromado
Dourado fosco / Preto fosco



**SUPORTE CABIDEIRO DV 807
REDONDO | ZAMAC**

ACABAMENTOS
Branco brilho / Cromado
Dourado fosco / Preto fosco

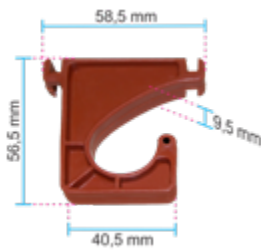

**SUPORTE CABIDEIRO
"J" 1091 | PLÁSTICO**

ACABAMENTO
Marron



**SUPORTE CABIDEIRO AÉREO
DV 906 OBLONGO | ZAMAC**

ACABAMENTOS
Branco brilho / Cromado
Dourado fosco / Preto fosco



**SUPORTE CABIDEIRO AÉREO
DV 907 REDONDO | ZAMAC**

ACABAMENTOS
Branco brilho / Cromado
Dourado fosco / Preto fosco



**BUCHAVAZADA
| ZAMAC**

ACABAMENTO Natural
TAMANHO 5/16" x 15mm
FURO 4,4mm

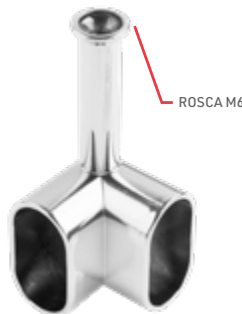

**SUPORTE CABIDEIRO
AÉREO 90° DUPLO DV 706
OBLONGO | ZAMAC**

ACABAMENTOS Branco brilho / Cromado
Dourado fosco / Preto fosco
OBSERVAÇÃO Acompanha parafuso M6x25mm

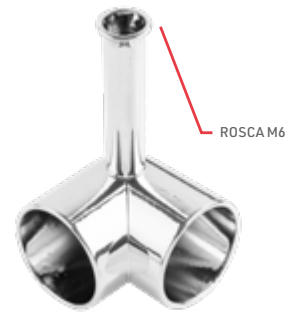

**SUPORTE CABIDEIRO
AÉREO 90° DUPLO DV 707
REDONDO | ZAMAC**

ACABAMENTOS Branco brilho / Cromado
Dourado fosco / Preto fosco
OBSERVAÇÃO Acompanha parafuso M6x25mm

MÃO FRANCESA | TRADICIONAL



Ferro Leve

TAMANHOS

15x10cm / 20x13cm
25x15cm / 30x18cm
35x20cm / 40x25cm

LARG. APROX. 17mm
ESP. APROX. 2,2mm

ACABAMENTOS

Branco / Preto fosco



Ferro Forte

TAMANHOS

25x15cm / 30x17cm
35x20cm / 40x26cm
45x26cm / 50x28cm

LARG. APROX. 22mm
ESP. APROX. 3,2mm

ACABAMENTOS

Branco / Preto fosco



Extraforte

TAMANHOS

20x14cm / 25x20cm
30x25cm / 40x40cm
50x40cm

LARG. APROX. 32mm
ESP. APROX. 3,2mm

ACABAMENTO

Branco



MÃO FRANCESA | PARA VIDRO

TAMANHOS

10cm x 9cm / 15cm x 12cm
20cm x 13cm / 25cm x 16cm
30cm x 16cm

LARG. APROX.

17mm

ESP. APROX.

2,2mm

ACABAMENTOS

Branco / Cromado

*Com ventosas e aba frontal 11mm



MÃO FRANCESA | DOBRÁVEL

REFERÊNCIAS CAPACIDADE DE PESO COM 2 UNIDADES TAMANHOS ACABAMENTO

REFERÊNCIAS	CAPACIDADE DE PESO COM 2 UNIDADES	TAMANHOS A	TAMANHOS B	ACABAMENTO
DVD18	80Kg	16,5cm	18cm	Branco
DVD28	70Kg	16,5cm	28cm	Branco
DVD38	60Kg	16,5cm	38cm	Branco

SUGESTÃO

DVD18 (18cm): utilizar MDF com no máximo 25cm de largura
DVD28 (28cm): utilizar MDF com no máximo 35cm de largura
DVD38 (38cm): utilizar MDF com no máximo 45cm de largura

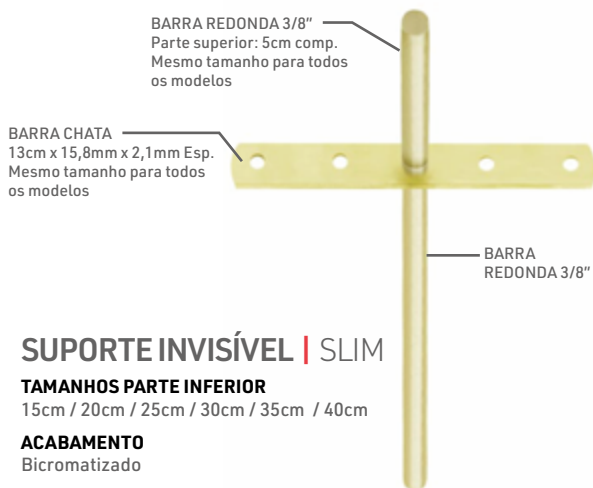

SUPORTE INVISÍVEL | SLIM

TAMANHOS PARTE INFERIOR

15cm / 20cm / 25cm / 30cm / 35cm / 40cm

ACABAMENTO

Bicromatizado

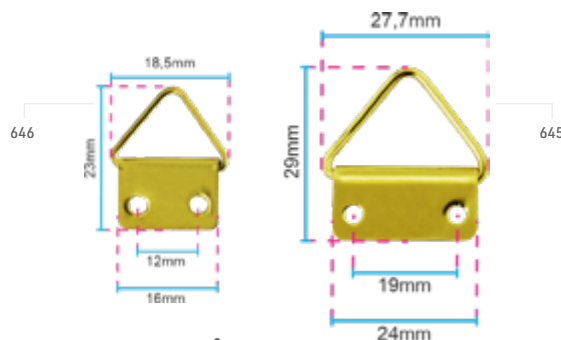

SUPORTES TRIÂNGULO

REFERÊNCIAS ACABAMENTO

646 - Suporte médio
645 - Suporte grande

ACABAMENTO

Bicromatizado

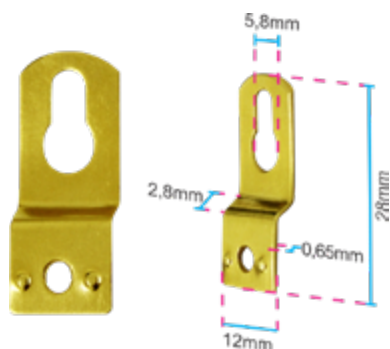

SUPORTE GARRA PARA ESPELHO E QUADRO | 552

ACABAMENTO

Bicromatizado

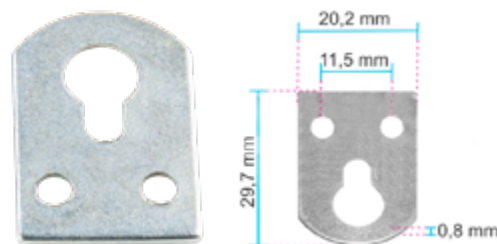

SUPORTE PARA ESPELHO | 3017

ACABAMENTO

Zincado

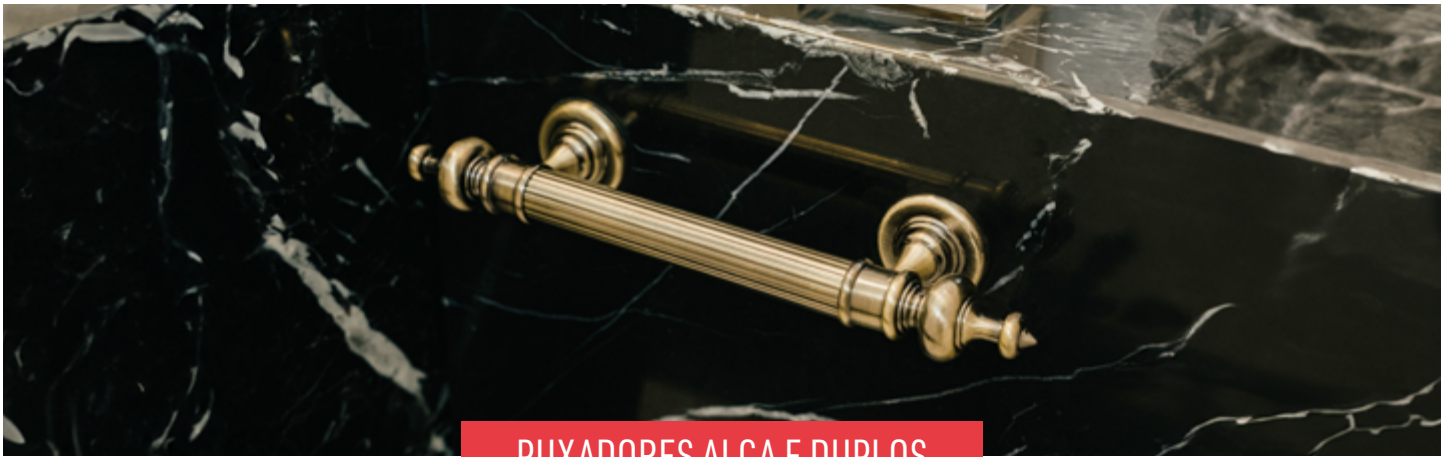

PUXADORES ALÇA E DUPLOS



**PUXADOR ALÇA T0185 | TUBO INOX
COM PONTEIRAS EM ALUMÍNIO**

FURAÇÃO	COMPRIMENTO	DIÂMETRO	ACABAMENTOS
150mm	265mm	16mm	1 Dourado 2 Preto fosco



**PUXADOR ALÇA T0186 | TUBO INOX
COM PONTEIRAS EM ALUMÍNIO**

FURAÇÃO	COMPRIMENTO	DIÂMETRO	ACABAMENTOS
150mm	265mm	20mm	1 Dourado rústico 2 Preto fosco



**PUXADOR LANÇA 827 | TUBO INOX
COM PONTEIRAS EM ALUMÍNIO**

FURAÇÕES	COMPRIMENTOS	DIÂMETRO	ACABAMENTOS
400mm	760mm	38mm	1 Cobre rústico 2 Preto fosco
600mm	960mm		
900mm	1300mm		



**PUXADOR PINHA 709 | TUBO INOX
COM PONTEIRAS EM ALUMÍNIO**

FURAÇÕES	COMPRIMENTOS	DIÂMETRO	ACABAMENTOS
400mm	640mm	38mm	1 Dourado rústico 2 Preto fosco
600mm	840mm		
900mm	1180mm		





PUXADOR TOP RETO 1" | INOX 201

FURAÇÕES	COMPRIMENTOS	DIÂMETRO	ACABAMENTOS
200mm	300mm	1" (25,4mm)	1 Cobre
300mm	400mm		2 Cromado
400mm	500mm		3 Dourado fosco
500mm	600mm		4 Laterais cromadas
600mm	800mm		c/ meio cromado fosco
			5 Preto fosco



PUXADOR TOP BBB | INOX 304

FURAÇÕES	COMPRIMENTOS	LARGURA	ACABAMENTOS
300mm	500mm	40mm	1 Cobre
400mm	600mm		2 Cromado
600mm	800mm	ESPESSURA	3 Dourado fosco
800mm	1000mm	10mm	4 Preto fosco
900mm	1200mm		



INOX
304



BARRA DE APOIO | EM INOX

TAMANHOS	ACABAMENTO	DIÂMETRO	ESPESSURA
400mm	Cromado	1.1/4"	2mm
600mm			
800mm			

INFORMAÇÕES

Embalagem plastificada com buchas, parafusos e tampas de acabamento para esconder os parafusos

Aprovada pela norma ABNT BDR 9050:2015



PINO PIVOTANTE | PARA PORTA

ACABAMENTO	CAPACIDADE
Escovado	120Kg

- Utilizado em portas de madeira
- Acompanha buchas e parafusos
- Material: Aço Inox 201
- Embalado em blister



PINO PIVOTANTE | PARA PORTA

ACABAMENTO	CAPACIDADE
Escovado	300Kg

- Utilizado em portas de madeira
- Acompanha buchas e parafusos
- Material: Aço Inox 304
- Embalado em blister

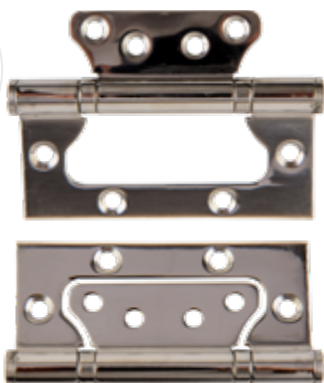

DOBRADIÇA | PARA PORTA

ACABAMENTOS

Escovado
Polido
Preto fosco
Cromado metalizado
Branco brilho
Dourado fosco

MATERIAL DOBRADIÇA

Inox 201
Inox 201
Aço carbono
Aço carbono
Aço carbono
Aço carbono

MATERIAL PARAFUSO

Inox 201
Inox 201
Ferro preto
Ferro cromado
Ferro branco
Ferro dourado

INFORMAÇÕES

- Acompanham parafusos
- Cartela embalada em blister com 3 unidades
- Não precisa cava na porta - Fixação direta e rápida

CAPACIDADE

Portas de até 40kg

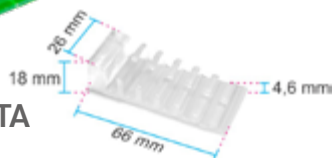

BATENTE DE PORTA | STOPORTAS

ACABAMENTO

Transparente

INFORMAÇÕES

- Trava auto-adesiva para portas
- Cartela em blister com 2 unidades

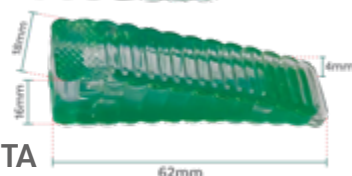

BATENTE DE PORTA | STOPORTAS SLIM

ACABAMENTO

Transparente

INFORMAÇÕES

- Auto-adesivo
- Super-resistente
- Mais discreto
- Ideal para pisos cerâmicos, de madeira e vinílicos
- Cartela com 1 unidade



BATENTE PARA PORTA | 831

MATERIAL

Corpo do produto Inox
Bolinha ferro cromado

ACABAMENTO

Escovado

FIXAÇÃO

Não aparente



BATENTE PARA PORTA | 200

MATERIAL

Zamac

ACABAMENTO

Cromado

FIXAÇÃO

Não aparente



BATENTE PARA PORTA | 208

MATERIAL

Zamac

ACABAMENTO

Cromado

FIXAÇÃO

Externa aparente



NIVELADOR | BASE METAL

BASE EMBORRACHADA

REFERÊNCIAS	HASTE	BASE
DV595	1/4x1"	22mm
DV603	1/4x1"	35mm
DV596	5/16x1"	35mm
DV597	3/8x1"	35mm



NIVELADOR | SEXTAVADO

BASE PLÁSTICA PRETA

REFERÊNCIAS	HASTE	BASE
DV585	1/4x3/4"	27mm
DV500	5/16x1"	27mm
DV550	3/8x1"	27mm



NIVELADOR | OITAVADO

BASE PLÁSTICA PRETA

REFERÊNCIA	HASTE	BASE
DV580	1/4x3/4"	22mm



BUCHA | PLÁSTICA

ROSCA METÁLICA

ROSCA
1/4" - 5/16" - 3/8"



PONTEIRA INTERNA | REDONDA

TAMANHOS (Polegadas) **COR**
 5/8" - 3/4" - 7/8" Preta
 1" - 1.1/4" - 1.1/2"
 2" - 2.1/2" - 3"



PONTEIRA INTERNA | QUADRADA E RETANGULAR

TAMANHOS (mm) **COR**
 15x15 - 20x20 - 25x25 - 30x30 Preta
 40x40 - 50x50 - 20x30 - 30x50
 40x20 - 40x30 Abaulada



PONTEIRA EXTERNA | REDONDA

TAMANHOS (Polegadas) **CORES**
 5/8" - 3/4" - 7/8" - 1" - 1.1/4" Branca
 Preta



PASSADOR DE FIO | PF18

DIÂM. EXT. **CORES**
 68mm Branca
DIÂM. FURO Cinza
 60mm Marrom
 Marfim
ALTURA Preta
 18mm



SUPORE PRATELEIRA

DIÂM. EXT. **CORES**
 15mm Branca
DIÂM. FURO Mogno
 5mm Preta
LARGURA
 10mm



SAPATA PLÁSTICA | COM PREGO

DIÂMETRO **ALTURA** **ACABAMENTO**
 25mm 10mm Preto e Marrom



| SAPATAS DESLIZADORAS

<p>1 DV800 Parte inferior metálica e superior plástica BASE METÁLICA 24mm BASE PLÁSTICA 18mm</p>	<p>2 DV900 Parte inferior plástica e superior metálica BASE METÁLICA 18mm BASE PLÁSTICA 24mm</p>
--	--



| VENTOSAS

<p>1 V100.03 Apoio</p>	<p>2 V101.03 6mm</p>	<p>3 V102.99 6mm - Alta</p>	<p>4 V103.03 10mm</p>
--	--	---	---

• Transparente



SUPORE ARTICULADO | PARA TV

UNIVERSAL DE 10 A 46"
 • Com manual de instalação
 • Acompanha kit de instalação com parafusos, buchas e arruelas

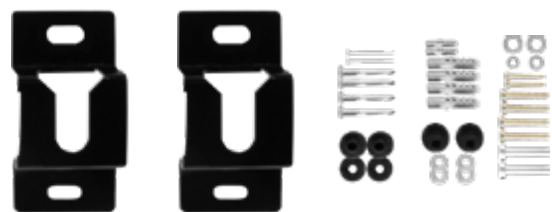

SUPORE FIXO PARA TV | COMPACTO

UNIVERSAL DE 10 A 71"
 • Encartelado em blister
 • Manual de instalação no verso do blister
 • Acompanha kit de instalação com parafusos, buchas e arruelas

Tambor curto
(com chave)



Tambor longo
(com chave)



FECHADURA TAMBOR

REFERÊNCIAS	ALTURAS
990 - Tambor curto	22mm
991 - Tambor longo	32mm



FECHADURA 012

2 VOLTAS

ACABAMENTO Zincado
OBSERVAÇÃO Acionamento com a Chave Colonial 1030



TRINCO DE FERRO

ACABAMENTO
Bicromatizado



FECHO ROLETE

ACABAMENTOS
Bicromatizado
Zincado

- Acompanha parafusos



DOBRADIÇA INVISÍVEL 180° PARA MÓVEIS | ZAMAC

ACABAMENTO Niquelado
MEDIDAS 42x12mm

- Embalado individualmente
- Acompanha parafusos

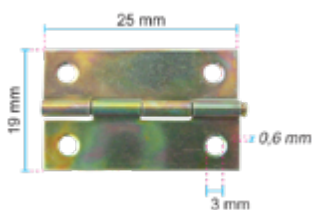

DOBRADIÇA

3008

ACABAMENTO
Bicromatizado

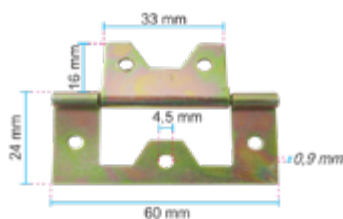

DOBRADIÇA

4000

ACABAMENTO
Bicromatizado

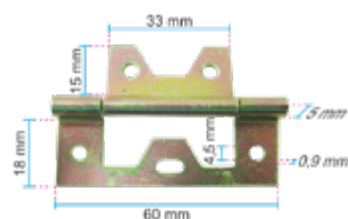

DOBRADIÇA

4000/2

ACABAMENTO
Bicromatizado

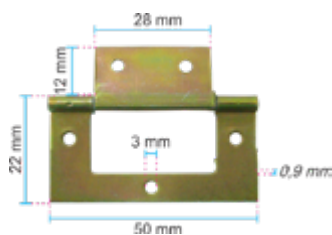

DOBRADIÇA

4004R

ACABAMENTO
Bicromatizado

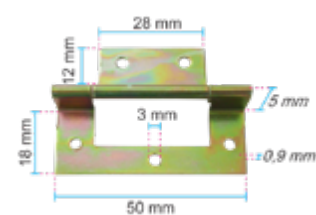

DOBRADIÇA

4004L

ACABAMENTO
Bicromatizado

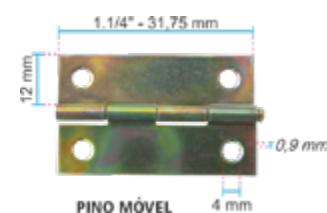

DOBRADIÇA

1.1/4" | 25010

ACABAMENTO
Bicromatizado

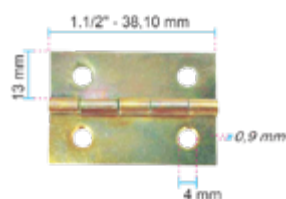

DOBRADIÇA

1.1/2" | 25012

ACABAMENTO
Bicromatizado

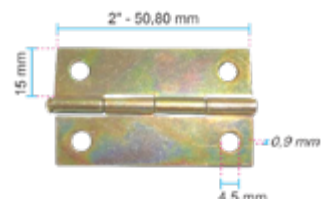

DOBRADIÇA 2"

25020

ACABAMENTO
Bicromatizado

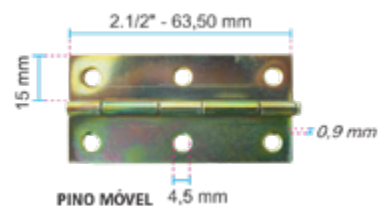

DOBRADIÇA

2.1/2" | 25021

ACABAMENTO
Bicromatizado



FELTRO ADESIVO | EVA



| Feltro Adesivo EVA
Redondo 22mm



| Feltro Adesivo EVA
Redondo 45mm



| Feltro Adesivo EVA
Quadrado 22mm



| Feltro Adesivo EVA
Quadrado 45mm

OBSERVAÇÃO

- Com fita adesiva para fixação

PROTECTOR DE QUINA | SILICONE



| 1082 - Protetor de quina
pequeno 30x15mm Redondo



| 1080 - Protetor de quina
grande 40x15mm Redondo



| 1081 - Protetor de quina
40x40x15mm Quadrado

OBSERVAÇÃO

- Com fita adesiva para fixação



Linha Self-Service

Atendendo à grande procura de Home Centers e lojas de Materiais de Construção por nossos produtos, desenvolvemos a Linha Self-Service.

Um amplo mix de produtos embalados para gôndolas que facilitam a exposição e a comercialização dos itens. Já com código de barras.

Abaixo os produtos que compõem a linha self-service

► Suportes Prateleiras | Zamac



Suporte 2 furos 1026 Tradicional

- Quantidade por cartela: 10 peças + 20 parafusos 3,5x16
- Cantoneira Branca: Parafuso Branco
- Cantoneira Niquelada: Parafuso Zincado



Suporte 2 furos 1027 Maciço

- Quantidade por cartela: 10 peças + 20 parafusos 3,5x16
- Cantoneira Branca: Parafuso Branco
- Cantoneira Niquelada: Parafuso Zincado



Suporte 3 furos 2026

- Quantidade por cartela: 10 peças + 30 parafusos 3,5x16
- Cantoneira Branca: Parafuso Branco
- Cantoneira Niquelada: Parafuso Zincado

► Suportes e Cantoneiras | Metal



Suportes triângulo

- Quantidade por cartela: 2 peças
- Não acompanha parafusos



Cantoneira universal DV 3020

- Quantidade por cartela: 2 peças + 6 parafusos
- Acompanham 6 parafusos 3,5x16 brancos



Cantoneira 4 furos

- Quantidade por cartela: 1 peça
- Não acompanha parafusos



Cantoneira leve

- Não acompanha parafusos
- Quantidade por cartela:

- 1x1: 2 peças • 1.1/2x1.1/2: 2 peças • 2x2: 2 peças
- 2.1/2x2.1/2: 1 peça • 3x3: 1 peça • 3.1/2x3.1/2: 1 peça

► Cantoneiras Metálicas | com Capa Plástica



DV 3060 Extra Reforçada

- Quantidade por cartela: 1 Conjunto
- Não acompanham parafusos



Cantoneira 87117

- Quantidade por cartela: 1 Conjunto
- Não acompanham parafusos

► Cabides | ZAMAC



Cabide Pequeno

- Quantidade por cartela: 1 peça + 1 parafuso
- Acompanha 1 parafuso 3,5x16 na cor do cabide



Cabide Médio

- Quantidade por cartela: 1 peça + 1 parafuso
- Acompanha 1 parafuso 3,5x16 na cor do cabide



Cabide Grande

- Quantidade por cartela: 1 peça + 2 parafusos
- Acompanham 2 parafusos 3,5x16 na cor do cabide



Cabide Duplo

- Quantidade por cartela: 1 peça + 2 parafusos
- Acompanham 2 parafusos 3,5x16 na cor do cabide

► Suporte Cabideiro

| Zamac



DV 806

- Quantidade por cartela: 2 peças + 6 parafusos
- Acompanham 6 parafusos 3,5x16 zincados

DV 906

- Quantidade por cartela: 1 peça + 2 parafusos
- Acompanham 2 parafusos 3,5x16 zincados

DV 807

- Quantidade por cartela: 2 peças + 6 parafusos
- Acompanham 6 parafusos 3,5x16 zincados

DV 907

- Quantidade por cartela: 1 peça + 2 parafusos
- Acompanham 2 parafusos 3,5x16 zincados

DV 706

- Quantidade por cartela: 1 peça + 1 parafuso
- Fixação na parte superior com Rosca M-6
- Acompanha parafuso M-6 x 25

DV 707

- Quantidade por cartela: 1 Peça + 1 Parafuso
- Fixação na parte superior com Rosca M-6
- Acompanha parafuso M-6 x 25

► Puxadores | Zamac



Puxador Miracoli | ZM 5015

- Quantidade por cartela: 1 peça + 2 parafusos
- Acompanham 2 parafusos M4 x 20mm



Puxador Duomo | ZM 5000

- Quantidade por cartela: 1 peça + 1 parafuso
- Acompanha 1 parafuso M4 x 20mm



Puxador Uno | 5/8"

- Quantidade por cartela: 1 peça + 1 parafuso
- Acompanha 1 parafuso M4 x 20mm



Puxador Nobile | DZ 28

- Quantidade por cartela: 1 peça + 4 parafusos
- Acompanham 4 parafusos 3,5x16 na cor do puxador
- Fixação externa
- Furação auxiliar 119mm



Puxador Tradição | DZ 950

- Quantidade por cartela: 1 peça + 4 parafusos
- Acompanham 4 Parafusos 3,5x16 na cor do puxador
- Fixação externa
- Comprimento total 100mm



Puxador Tradição | DZ 954

- Quantidade por cartela: 1 peça + 4 parafusos
- Acompanham 4 parafusos 3,5x16 na cor do puxador
- Fixação externa
- Comprimento total 120mm

► Sapatas e Niveladores



Nivelador Base Metal

- Quantidade por cartela: 1 peça + 1 bucha 1/4
- Acompanha 1 bucha 1/4



Nivelador Oitavado

- Quantidade por cartela: 1 peça + 1 bucha 1/4
- Acompanha 1 bucha 1/4



Sapatas de Silicone

- Quantidade por cartela: 2 peças
- Não acompanham parafuso



Sapatas Deslizadoras c/ Prego

- Quantidade por cartela: 1 peça

► Ponteiras em PVC

| Acessórios Plásticos



Ponteiras Internas Redondas, Quadradas e Retangulares

- Quantidade por cartela: 4 peças



Ponteira Externa PVC.B

- Quantidade por cartela: 4 peças



Suporte Prateleira

- Quantidade por cartela: 4 peças
- Não acompanha parafuso



Passador de Fio - PF 18

- Quantidade por cartela: 1 peça

► Rodízios Giratórios



Rodízios Plásticos

- Quantidade por cartela: 1 peça
- Não acompanham parafuso



Rodízio de Silicone

- Quantidade por cartela: 1 peça
- Não acompanham parafuso

► Para portas



Fecho Rolete

- Quantidade por cartela: 1 peça + 4 parafusos
- Acompanham 4 parafusos para fixação



Trinco de Ferro

- Quantidade por cartela: 1 peça + 2 parafusos
- Acompanham 2 parafusos 3,5x16 zincados



Trava Plástica com Pistão

- Quantidade por cartela: 1 peça + 4 parafusos
- Acompanham 4 parafusos 3,5x16 zincados



Fecho Porta Magnético

- Quantidade por cartela: 1 peça + 4 parafusos
- Acompanham 4 parafusos 3,5x16 zincados

► Dobradiças | Bicromatizadas



3008

- Quantidade por cartela: 2 peças + 8 parafusos
- Acompanham 8 parafusos 3,5x16 zincado



4000

- Quantidade por cartela: 2 peças + 10 parafusos
- Acompanham 10 parafusos 3,5x16 zincados



4000/2

- Quantidade por cartela: 2 peças + 10 parafusos
- Acompanham 10 parafusos 3,5x16 zincados



4004L

- Quantidade por cartela: 2 peças + 10 parafusos
- Acompanham 10 parafusos 3,5x16 zincados



4004R

- Quantidade por cartela: 2 peças + 10 parafusos
- Acompanham 10 parafusos 3,5x16 zincados



25010 - 1.1/4"

- Quantidade por cartela: 2 peças + 8 parafusos
- Acompanham 8 parafusos 3,5x16 zincados



25012 - 1.1/2"

- Quantidade por cartela: 2 peças + 8 parafusos
- Acompanham 8 parafusos 3,5x16 zincados



25020 - 2"

- Quantidade por cartela: 2 peças + 8 parafusos
- Acompanham 8 parafusos 3,5x16 zincados



25021 - 2.1/2"

- Quantidade por cartela: 2 peças + 12 parafusos
- Acompanham 12 parafusos 3,5x16 zincados

► Botões / Suportes para Vidros



Botão Francês Zamac

- Quantidade por cartela: 1 peça
- Não acompanha parafuso



Botão Francês Plástico

- Quantidade por cartela: 1 peça
- Não acompanha parafuso



Suporte para Vidro Redondo (Fenda)

- Quantidade por cartela: 1 peça
- Não acompanha parafuso
- Com parafuso lateral já rosqueado

► Ventosas e Apoios / Batente de Silicone e Puxador para Box



Ventosa

- Quantidade por cartela: 4 peças



Puxador para Box 5/8"

- Quantidade por cartela: 1 peça
- Acompanha 1 Haste M4 x 20mm
- Acompanham 2 arruelas plásticas



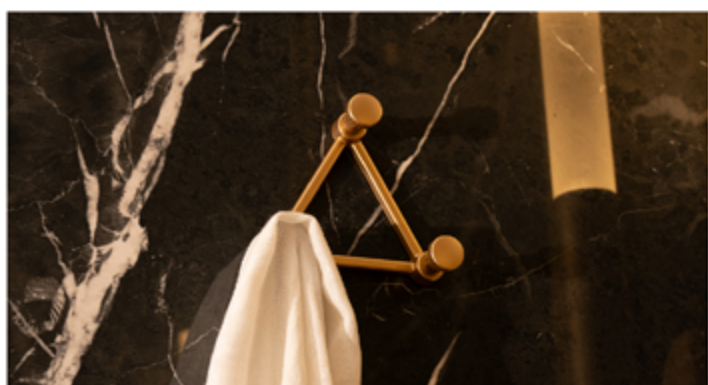
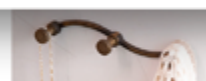

 **CRIATIVA, MODERNA, INOVADORA**



 CRIATIVA, MODERNA, INOVADORA



www.criativapuxadores.com.br

 49 3522-5165  49 3522-2052
vendas@criativapuxadores.com.br

Rua Prefeito Udilo Antônio Coppi, 403
Distrito Industrial - Joaçaba - SC - 89600-000

